

Varenummer: 0107067

Beskrivelse: Seeger låsering AK 50 DIN 983

Mål

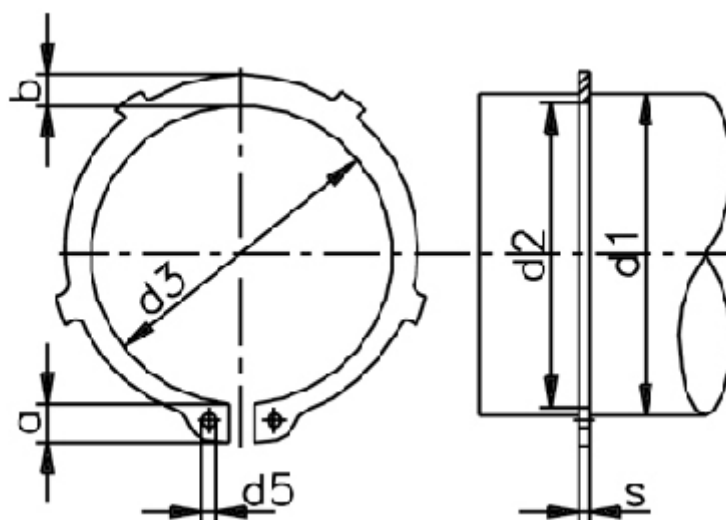

a max	= 8.2	d5 min	= 2.5	Nominal træk	= 4.5
AN mm ²	= 228.0	FN kN	= 38.00	s	= 2.00
Antal takker	= 6	FRg kN	= 14.4	t	= 1.50
b	= 5.0	FR kN	= 73.3	Tang	= ZGA-3
Betegnelse	= AK 50	g	= 2.0	tol	= -0.07
d1	= 50	K kN-mm	= 133.0	tol	= +0,39-0,90
d2	= 47.0	m min	= 2.15	tol	= -0.25
d3	= 45.8	n abl x 1000	= 10	vægt kg/1000	= 11.50